

# ROTOR NOZZLE

## Category from 350 bar hand-held

### Operating Instructions



Year of construction 2010 ... + production quarter  
RA, RB,  
BA 0304830 R01 2021-10

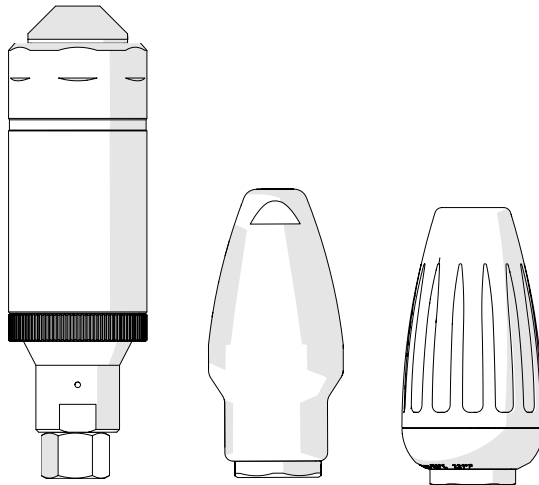



Operating instructions for  
hand-held rotor nozzles from 350 bar



MADE  
IN  
GERMANY

TEV-JÄGER

 <b>Basics</b> .....	<b>5</b>
Safety notices	6
Explanatory information	7
Overview of possible rotor nozzle components from 400-2500 bar	8
Scope of delivery of the rotor nozzle	8
Tools required for assembly	9
Tools required for repair	9
How does a rotor nozzle work?	10
Components and their function	11
Intended use	13
Requirements for the surface to be cleaned	13
Requirements for the user of the system	13
Space requirement	13
Maximum performance data	13
Technical changes	13
Water quality for operation	14
Requirements for the high pressure cleaner	14
EC Declaration of Conformity	14
For your safety	16
 <b>Working safely</b> .....	<b>18</b>
<b>Working safely</b> .....	<b>19</b>
Select a safe position	19
Watch out for sources of danger in the work area	19
Safety when cleaning	19
Checking and preparing high-pressure equipment	19
 <b>Commissioning</b> .....	<b>20</b>
<b>Preparing and connecting the rotor nozzle</b> .....	<b>21</b>
Unpacking and checking	21
Mounting the rotor nozzle on the lance	21

 <b>Working</b> .....	<b>23</b>
<b>Working with the rotor nozzle</b> .....	<b>24</b>
Determine the correct working distance.....	24
Interrupting work.....	25
Finishing work.....	25
 <b>Repair</b> .....	<b>26</b>
<b>Rotor nozzle defective</b> .....	<b>27</b>
Occurring error patterns.....	27
Troubleshooting measure.....	27
<b>Install repair kit</b> .....	<b>27</b>
Open pressure housing.....	27
Removing bearing unit.....	28
Inserting a new bearing unit.....	28
Inserting a new rotor.....	29
Changing the O-ring on the driving plug.....	29
Assembling the rotor nozzle.....	30
 <b>Storage</b> .....	<b>32</b>
<b>Storing the rotor nozzle</b> .....	<b>33</b>
Drain rotor nozzle.....	33
 <b>Disposal</b> .....	<b>34</b>
<b>What happens with the waste?</b> .....	<b>35</b>
Packaging.....	35
Protective cap, rotor, bearing unit.....	35
Pressure housing, driving plug.....	35
Consumable water.....	35



It is **IMPORTANT** that you read these operating instructions **CAREFULLY BEFORE USE** and to **KEEP FOR FUTURE REFERENCE**.

Visit our homepage at regular intervals and check for the latest version of the operating instructions.

The operating instructions are intended for..

Rotor nozzles from year of manufacture 1989. The operating manual has revision level R01.



# Components of a rotor nozzle and their function

Here you will find information about:  
the components of the rotor nozzle



# Explanation of notices

## Safety notices

These notices are for your safety. The notices can be found in the general part on safety and always at an action that requires a separate notice.



Failure to comply will lead to serious injury or death.



Failure to comply may lead to serious injury or death.



Failure to comply may lead to injuries.



Failure to comply may lead to material damage and impair the function of the product.

*Attention –*

Additional information about product operation.



## Explanatory information

This information can be found in the grey shaded illustration area. It helps you to find the right illustration for the heading in the text, to understand the details better, follow steps, complete movements and identify the position.

Clean thread

The title of the image indicates the **text** to which the figure belongs.

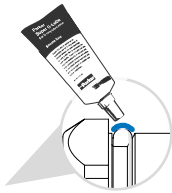

The detailed view highlights areas that are important.



The numbers on the figures are associated with the steps in the explanatory text. They always start anew at [1] on a double page.

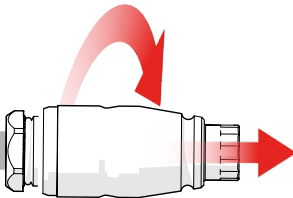

The red arrows always indicate a movement.



## Overview of possible rotor nozzle components from 400-2500 bar

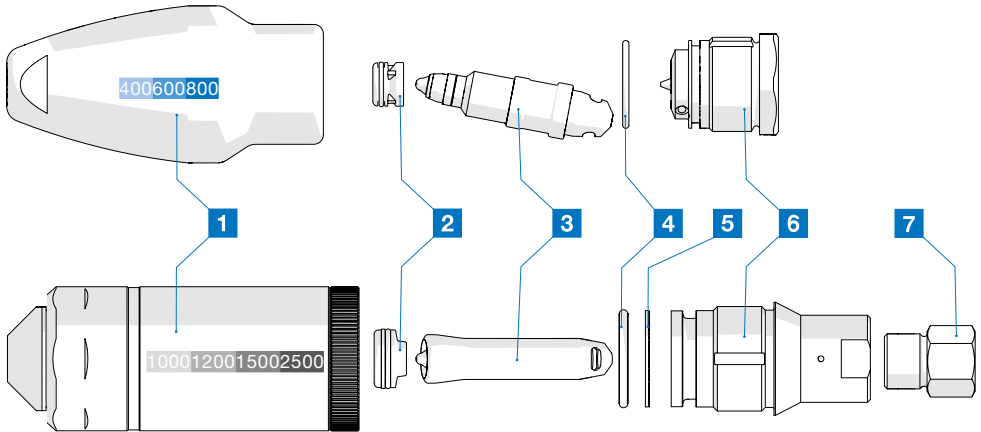

1 Pressure housing

2 Bearing unit

3 Rotor

4 O-ring

5 Support ring

6 Driving plug

7 Adapter (from 1,000 bar)

*\* The rotor nozzle shown is exemplary. The function of the components (if present) is always the same.*

## Scope of delivery of the rotor nozzle

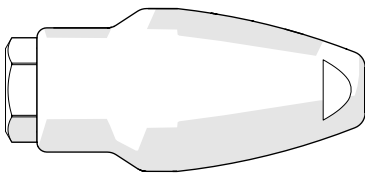

1 Rotor nozzle completely mounted

2 Adapter from 1,000 bar





### Tools required for assembly

1 4006008001000

Combination spanner size 32

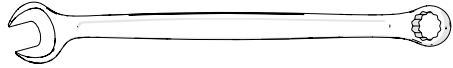

2 1000120015002500

Combination spanner size 36 + 27



3

LOCTITE 270



### Tools required for repair

1 4006008001000

Combination spanner size 24

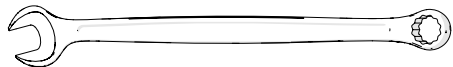

2 1000120015002500

Combination spanner size 48 + 27

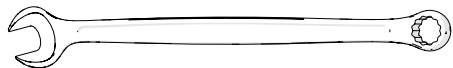

3

Mounting aid or e.g.  
pens



4

Assembly grease and lubricant  
Parker SUPER O-LUBE



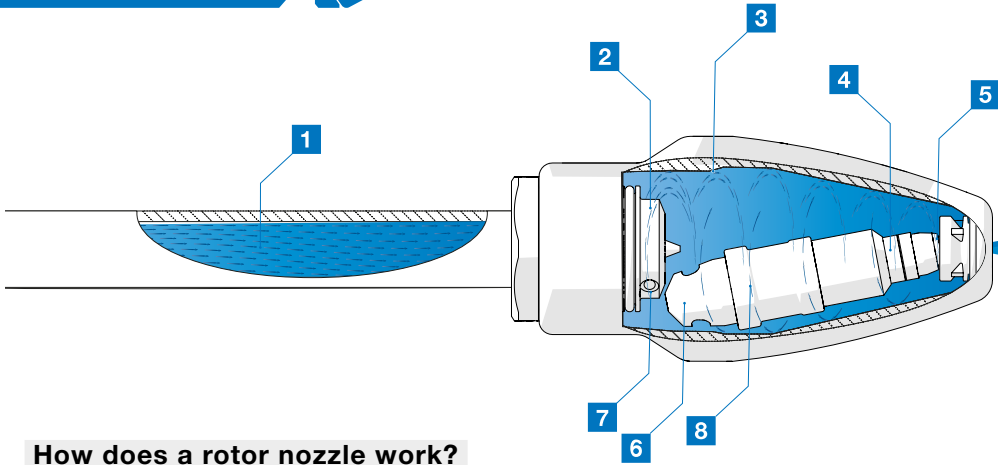

### How does a rotor nozzle work?

A rotor nozzle consists of a pressure housing, a driving plug, a rotor and a bearing unit. The rotor nozzle produces a hard point jet of high-pressure water that rotates around an axial centre.

But how is the point jet set in rotation with the help of the high-pressure water?

1. At the beginning, the high-pressure water is **1** is fed into the driving plug via a supply line (high-pressure lance).
2. The high-pressure water exits from the axially drilled holes **2** on the driving plug.
3. The high-pressure water fills the pressure housing **3**.
4. As the high-pressure water fills the pressure housing at a high velocity, the rotor is **4** is pushed into the bearing unit **5** and seals it against water leakage.

5. Now the high-pressure water can only exit the housing via the rotor **6** out of the housing via the rotor.

6. This creates a pressurised water flow.

7. As the water enters axially **7** through the holes of the driving plug, the water flow creates a rotating field **8**.

8. The resulting rotating field drags the rotor along. However, since the front part of the rotor is mounted in the bearing unit as a ball and cup, the rotor can only follow the rotating field with its rear part.

9. The centrifugal force acting on the rotor in the rotating field presses it against the pressure housing. In this way, the rotor completes a guided circular path.

10. This circular path is transferred to the point jet **9** which is generated by the water flowing out of the rotor, thus creating the rotating **10** point jet with which cleaning is then very effective.

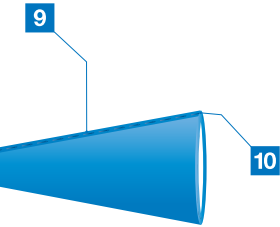

### Components and their function

**1 In the pressure housing.** It is the pressure body which, together with the driving plug, must withstand the specified maximum pressure.

**2 The driving plug** closes the pressure body and must withstand the pressure together with the pressure housing. In addition, the driving plug with its axial holes generates the rotating field that sets the rotor in rotation.

**3 The rotor** generates the backwater of the water with a built-in round nozzle. The desired water pressure is thus achieved in conjunction with the high-pressure cleaner. In addition to generating pressure, the rotor is also responsible for the circular path of the point jet.

**4 The bearing unit** is the axial pivot point. Using a ball-and-socket principle, the bearing unit together with the nozzle of the rotor forms the fixed pivot point for rotation.

**5 The O-rings** seal the pressure area on the driving plug and on the bearing unit.

**6 The support ring** is used from 1,000 bar and supports the O-ring at high pressure.

**7 The adapter** is supplied from 1,000 bar and adapts to the required connection thread.

1

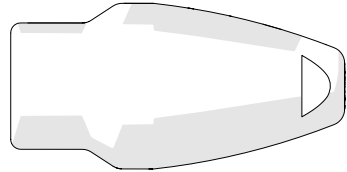

2

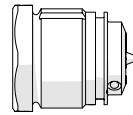

3

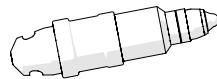

4



5



6

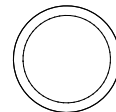

7

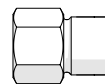



## Intended use

Here you will find the following information:  
For what purposes may the cleaner be used?  
Where may the cleaner be used? Who is  
allowed to use the cleaner?



## Intended use

The rotor nozzle is intended for surface cleaning with high-pressure water of non-organic surfaces.

## Requirements for the surface to be cleaned

The surface to be cleaned may not be organic. The surface must be suitable for being cleaned with a hard water jet.

## Requirements for the user of the system

*Operator:* The operator has been instructed by the plant operator about the tasks assigned to him and possible dangers in case of improper behaviour. Tasks that go beyond operation during normal operation may only be carried out by the operator if this is specified in these instructions and the operator has expressly entrusted him with them.  
*Qualified personnel:* Due to their technical training, knowledge, experience and familiarity with the relevant standards and regulations, qualified personnel are able to carry out the work assigned to them, to recognise possible dangers and to avoid risks independently.

*The following groups of people are not allowed to operate the rotor nozzle:*

- ▶ Persons with limited physical, sensory or mental abilities
- ▶ Children and young people under 18 years of age
- ▶ Persons who have not been trained

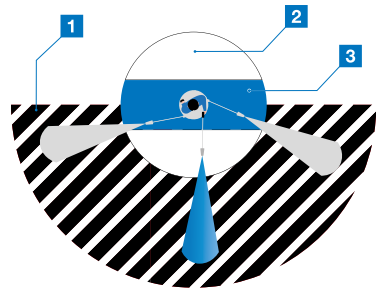

## Space requirement

- ▶ Locking range **1**: in front of operator 5 metres
- ▶ Safety zone **2**: 2 metres
- ▶ Movement space **3**: 2 metres

## Maximum performance data

The performance data depends on the type and can be found in the technical data of the individual types. The performance data given here are general data of this rotor nozzle category.

- ▶ Working pressure: between 350 and 2,500 bar
- ▶ Speed point jet: 3,500 to 5,000 revolutions per minute
- ▶ Noise level during normal operation: 95 decibels
- ▶ Vibration value: 9 m/s<sup>2</sup>
- ▶ The volume flow depends on the type and can be found in the technical data of the individual types.
- ▶ The maximum water temperature depends on the type and can be found in the technical data for the individual types.

## Technical changes

- ▶ The rotor nozzle must not be modified.



## Water quality for operation

- ▶ The rotor nozzle requires tap water.
- ▶ Make sure that the water does not contain any impurities.

## Requirements for the high pressure cleaner

- ▶ The high-pressure cleaner must correspond to the performance data of the rotor nozzle. Please refer to the technical data of your type.

## EC Declaration of Conformity

Der Hersteller / Inverkehrbringer erklärt hiermit, dass folgendes Produkt

Produktbezeichnung: Rotordüse Standard "Handgeführt" ab 350 Bar  
 Modellbezeichnung: Druckbereich Kennzahl 30, 35, 45, 55, 60, 65, 70, 75  
 Typbezeichnung: RA, RB,  
 Seriennummer: Produktionszeitraum in Quartal  
 Handelsbezeichnung: z.B. RA30-120-055-A  
 Baujahr: 1989  
 Beschreibung:  
 Düse mit rotierendem Punktstrahl. Angetrieben durch einen Wasserhochdruck der von einem Hochdruckreiniger erzeugt wird.

allen einschlägigen Bestimmungen der angewandten Rechtsvorschriften (nachfolgend) - einschließlich deren zum Zeitpunkt der Erklärung geltenden Änderungen - entspricht. Die alleinige Verantwortung für die Ausstellung dieser Konformitätserklärung trägt der Hersteller. Diese Erklärung bezieht sich nur auf die Maschine in dem Zustand, in dem sie in Verkehr gebracht wurde; vom Endnutzer nachträglich angebrachte Teile und/oder nachträglich vorgenommene Eingriffe bleiben unberücksichtigt.

Folgende Rechtsvorschriften wurden angewandt:

Maschinenrichtlinie 2006/42/EG  
 Lärmschutz-Richtlinie 2000/14/EG

Folgende harmonisierte Normen wurden angewandt:

EN 1829-1:2010	Hochdruck-Wasserstrahlmaschinen - Sicherheitsanforderungen - Teil 1: Maschinen
EN ISO 12100:2010	Sicherheit von Maschinen - Allgemeine Gestaltungsleitsätze - Risikobeurteilung und Risikominderung (ISO 12100:2010)
EN ISO 13732-1:2008	Ergonomie der thermischen Umgebung - Bewertungsverfahren für menschliche Reaktionen bei Kontakt mit Oberflächen - Teil 1: Heiße Oberflächen (ISO 13732-1:2006)
EN ISO 20643:2008/A1:2012	Mechanische Schwingungen - Handgehaltene und handgeführte Maschinen - Grundsätzliches Vorgehen bei der Ermittlung der Schwingungsemission (ISO 20643:2005)
EN ISO 3744:2010	Akustik - Bestimmung der Schalleistungs- und Schallenergiepegel von Geräuschquellen aus Schalldruckmessungen - Hüllflächenverfahren der Genauigkeitsklasse 2 für ein im Wesentlichen freies Schallfeld über einer reflektierenden Ebene (ISO 3744:2010)
ISO/TR 14121-2:2012	Sicherheit von Maschinen - Risikobeurteilung - Teil 2: Praktischer Leitfaden und Methodenbeispiele

Name und Anschrift der Person, die bevollmächtigt ist, die technischen Unterlagen zusammenzustellen:  
 Patrick Geiger, Dorfstrasse 16, 89185 Hüttisheim

Ort: Senden  
 Datum: 16.02.2021

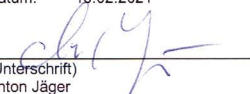
  
 (Unterschrift)  
 Anton Jäger

  
 (Unterschrift)  
 Patrick Geiger



# General safety instructions

Important instructions for safe use of the system and for establishing safe cleaning operations.



**For your safety**

Here you will find information about choosing a safe cleaning location, sources of danger in the work area and sources of danger when working.

**⚠ DANGER**



**Danger to life in severe weather conditions**

- ▶ Never work during a storm.  
This prevents the risk of being struck by lightning.

**⚠ CAUTION**



**Illness and hypothermia caused by bad weather**

- ▶ In bad weather, wear suitable protective clothing.  
This will protect you from illness caused by hypothermia.

**⚠ CAUTION**



**Damage to hearing on account of too much noise**

- ▶ Wear hearing protection while working.  
This will protect your hearing from damage caused by excessive noise.

**⚠ CAUTION**



**Risk of injury from overloading/strain**

- ▶ Take regular breaks.  
This will prevent injuries caused by physical and mental overload and fatigue.

**⚠ CAUTION**



**Risk of injury from flying dirt and parts**

- ▶ Wear safety goggles when working  
  
This will protect you from injuries caused by flying dirt and loose parts.





**CAUTION**



**Risk of injury due to prolonged use of vibrating machinery**

- ▶ Take regular breaks.  
This prevents injury occurring due to physical or mental exhaustion.

**CAUTION**



**Risk of injury from hot water**

- ▶ Watch out for leaks during hot water operation.  
This will protect you from scalding from hot water.

**CAUTION**



**Risk of injury due to overriding of safety devices**

- ▶ Never override safety devices.  
This prevents injury caused by any uncontrolled motion of the rotor nozzle during start-up.

**CAUTION**



**Risk of injury due to parts being flung away**

- ▶ Check the surface to be cleaned for objects before starting cleaning.  
This will protect you from injuries caused by parts being flung away.

**NOTICE**

**Frost damage**

- ▶ Make sure the rotor nozzle does not freeze up. This can cause damage to components.  
This protects the rotor nozzle against frost damage.



## Safe cleaning operation

Here you will find information about: choosing a safe cleaning location, sources of danger in the working area, sources of danger when working.



# Working safely

This section describes how to work safely with the rotor nozzle.

### Select a safe position

▶ Basically, the place of use and its conditions determine the cleaning work.

▶ Before setting up the equipment, carry out an inspection and consider how and where you can work safely.

### Watch out for sources of danger in the work area

- ▶ Slippery floor (stability)
- ▶ Too little space to move
- ▶ Flammable gas or dust mixtures
- ▶ Defective power connections
- ▶ ...

### Safety when cleaning

▶ When cleaning, make sure that you do not damage any surfaces, components or lines.

### Checking and preparing high-pressure equipment

Before starting work, check:

- ▶ the high-pressure connections for damage.
- ▶ the high-pressure hose for damage.
- ▶ the high-pressure gun for damage.

### CAUTION

#### Risk of injury due to slippery surface

- ▶ Check the surface for any situations that may facilitate slipping. This will protect you from falling and injuring yourself.

### CAUTION

#### Risk of injury due to falling

- ▶ Check your working area for unevenness and obstacles. This will protect you from injuries resulting from a fall.

### CAUTION

#### Risk of injury due to defective hoses and connections

- ▶ Check all high-pressure hoses and connections for damage. In this way you will protect yourself from injuries caused by a hard water jet that splashes out.

### CAUTION

#### Risk of injury to uninvolved persons

- ▶ Check whether unauthorised persons are in the work area. This will prevent personal injury due to collisions.



# Commissioning the rotor nozzle

Here you will find information about preparing the rotor nozzle for work.



## Preparing and connecting the rotor nozzle

Clean thread

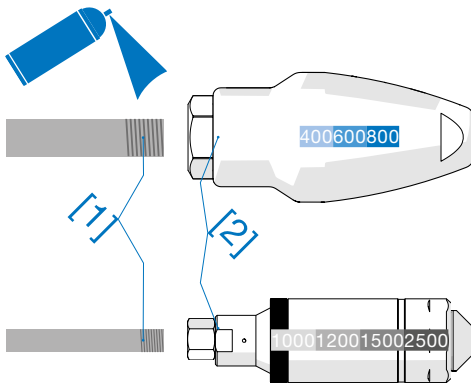

Apply LOCTITE

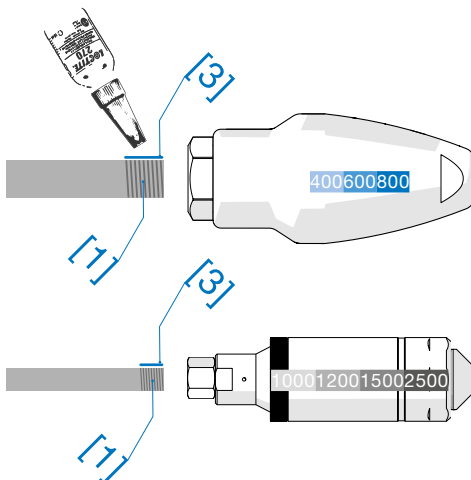

### Unpacking and checking

- ▶ Unpack the rotor nozzle.
- ▶ Check the rotor nozzle for external damage.
- ▶ Check whether all components are present.
- ▶ Check the functioning of the high-pressure gun.
- ▶ Check the connection threads on the rotor nozzle and the high-pressure lance.

### Mounting the rotor nozzle on the lance

- ▶ Clean the thread of the high-pressure lance [1] and the thread of the rotor nozzle [2] with a grease-dissolving cleaner. CAUTION – take care not to flush debris into the rotor nozzle.

- ▶ Secure the lance in a suitable way against twisting.

- ▶ Apply LOCTITE 270 as a line [3] lengthwise to the thread of the high pressure lance [1].



Screw on rotor nozzle

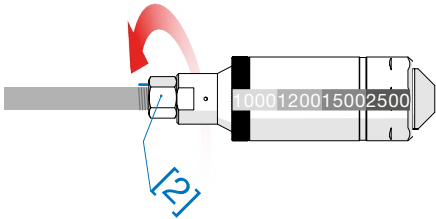
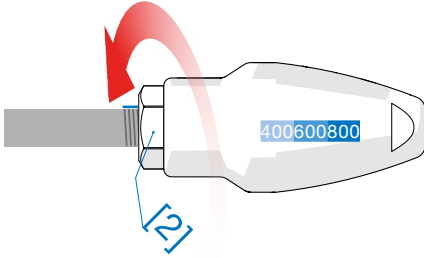

▶ Screw the rotor nozzle with the connection thread [2] onto the high-pressure lance.

▶ Place the combination spanner [4] on the hexagon of the driving plug [5].

▶ Screw the rotor nozzle tight with 15 Nm. CAUTION – the LOCTITE 270 has its final strength at room temperature after 6 hours.

## CAUTION

### Risk of injury during installation

▶ Wear gloves during installation. This will protect your skin from abrasions and pinching.

Tighten the rotor nozzle

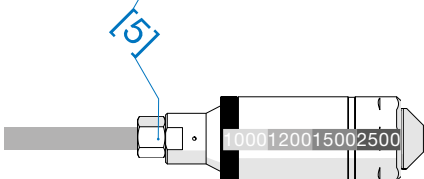
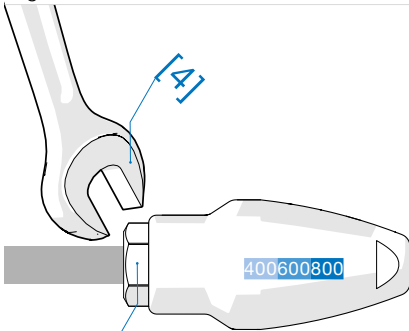



## Working with the rotor nozzle

Here you will find information about working with the rotor nozzle.



Rotor nozzle when opening the high-pressure gun

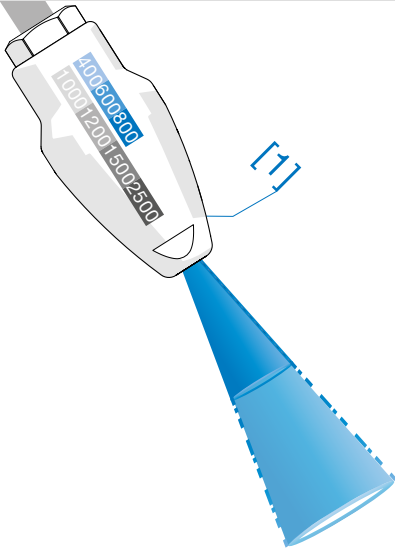

Rotor nozzle when opening the high-pressure gun

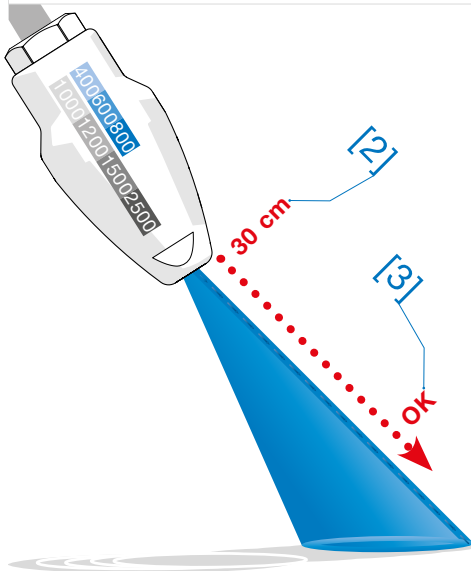

## Working with the rotor nozzle

### Determine the correct working distance

► When opening the high-pressure gun, hold the blasting pipe with the rotor nozzle [1] pointing downwards.

► Start your cleaning work with a distance of 20-30 cm [2].

► Now approach the surface to be cleaned until the best cleaning result is achieved [3]. CAUTION – if the distance is too short, sensitive surfaces can be damaged.

### WARNING

#### Risk of injury due to excessive operating pressure

► Do not operate the machine above the specified maximum operating pressure.

In this way you protect yourself from injuries caused by connecting parts being flung away in an uncontrolled

### CAUTION

#### Risk of injury from uncontrolled start-up

► Do not switch on the high-pressure cleaner until you have the lance with the cleaner safely in your hand.

This will prevent personal injury and damage to property due to uncontrolled start-up.





Empty the rotor nozzle

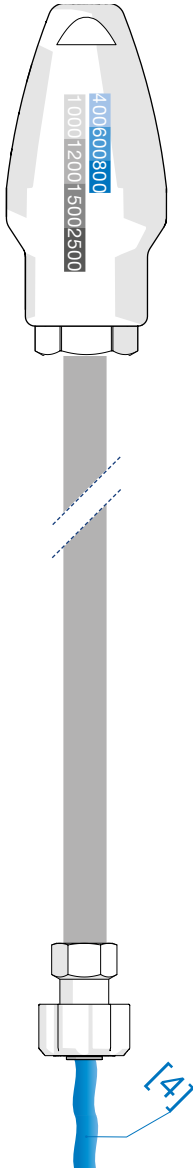

### Interrupting work

▶ Park the high-pressure lance with the rotor nozzle in a place protected from dirt. **CAUTION** – Dirt entering the rotor nozzle can damage it or increase wear.

### Finishing work

▶ Separate the high-pressure lance with the rotor nozzle from the high-pressure gun.  
▶ Let the water [4] run out of the rotor nozzle.

### CAUTION

#### Risk of injury due to slippery surface

▶ Check the surface for any situations that may facilitate slipping. This will protect you from falling and injuring yourself.

### CAUTION

#### Risk of injury due to incorrect installation of the joints

▶ Always hand-tighten and check the joints. This will protect you from injuries caused by uncontrolled flying joints.

### CAUTION

#### Risk of injury to uninvolved persons

▶ Check whether unauthorised persons are in the work area. This will prevent personal injury due to collisions.



## Repairing the rotor nozzle

Here you will find information about repairing the rotor nozzle.



Place the open-end spanner on the spanner flats

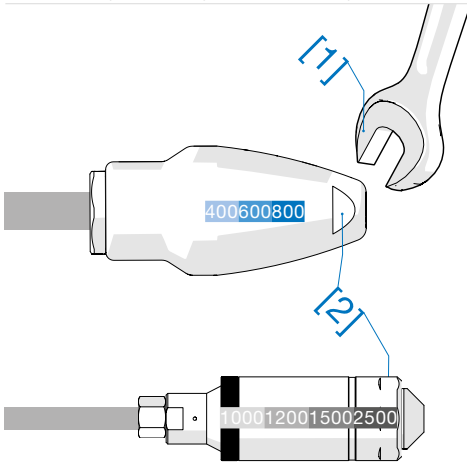

## Rotor nozzle defective

### Occurring error patterns

- ▶ No uniform cone
  - » Nozzle or bearing defective
- ▶ Uneven speed
  - » Nozzle or bearing worn
- ▶ Rotor nozzle has strong vibrations
  - » Rotor defective
- ▶ No rotation of the point jet
  - » Nozzle or bearing worn out

### Troubleshooting measure

- ▶ If the nozzle or bearing is defective or worn, a new rotor and bearing unit must be installed.

Unscrew the pressure housing

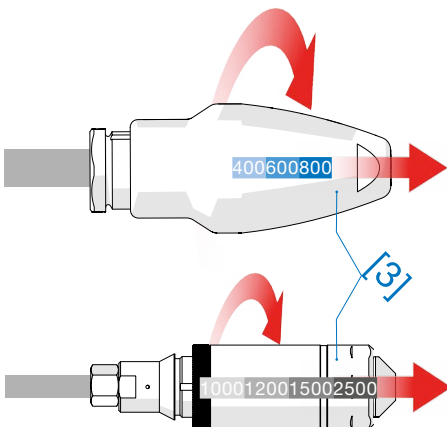

## Install repair kit

### Open pressure housing

- ▶ Secure the lance in a suitable way against twisting.
- ▶ Place the combination spanner [1] on the spanner flats [2] of the pressure housing tip.
- ▶ Unscrew the pressure housing [3] from the driving plug.



Remove rotor

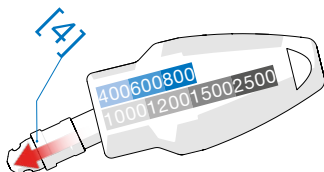

- ▶ Remove the old rotor [4] from the pressure housing.

### Removing bearing unit

- ▶ Take the assembly aid [5] and push the bearing unit [6] from the outside inwards out of the pressure housing. TIP – instead of the assembly aid, you can also use a round material that has the diameter of the hole in the pressure housing.

Remove bearing unit

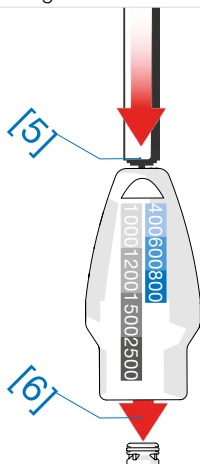

- ▶ Clean any dirt from the pressure housing.

### Inserting a new bearing unit

- ▶ Take the new bearing unit [7] and grease [8] the O-ring.

Grease O-ring

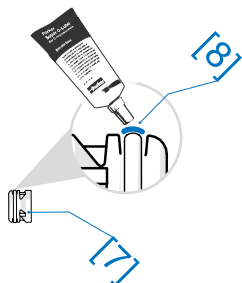

### ⚠ CAUTION

#### Risk of injury from unintentional start-up

- ▶ Always disconnect the rotor nozzle from the high-pressure cleaner during maintenance work. This will prevent personal injury and damage to property due to uncontrolled start-up.

### ⚠ CAUTION

#### Risk of injury during disassembly

- ▶ Wear gloves during disassembly. This will protect your skin from abrasions and pinching.



Bearing unit on mounting aid

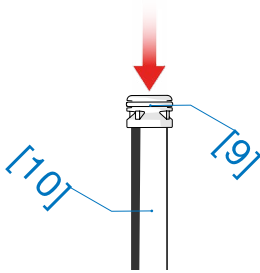

- ▶ Set the bearing unit [9] with the bearing seat first onto the [10] mounting aid. TIP – instead of the mounting aid, you can also use a biro, for example.

- ▶ Insert the pressure housing [11] over the assembly aid in your hand and press the bearing unit down to the pressure housing bottom [12].

### Inserting a new rotor

- ▶ Take the new rotor [13] and place it in the pressure housing with the nozzle first.
- ▶ Push the rotor until it rests properly in the bearing unit.

Insert bearing unit

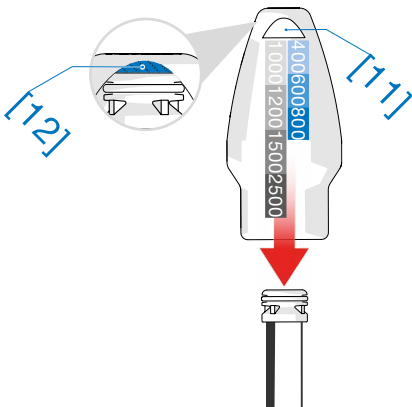

Insert rotor

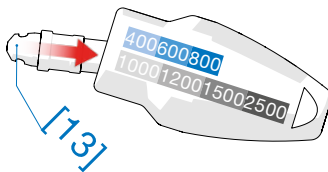

Drawing assembly aid

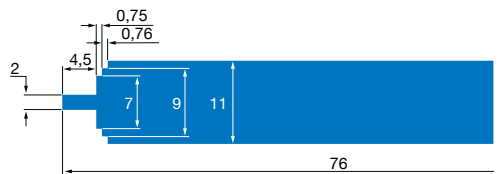



Remove O-ring

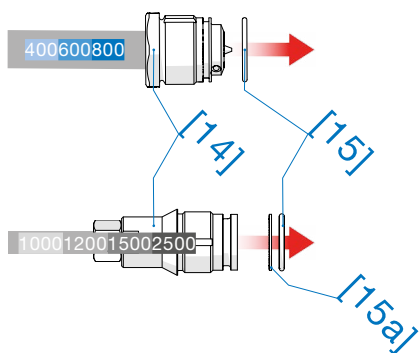

### Changing the O-ring on the driving plug

▶ Take the high pressure lance with the driving plug [14].

▶ Remove the old O-ring [15] and for rotor nozzles from 1,000 bar the support ring [15a].

▶ Clean the driving plug.

▶ Fit the new O-ring [16] and for rotor nozzles from 1,000 bar the support ring [16a]. Please note the order. The O-ring must rest in the recess [16b].

▶ Grease [17] the O-ring and the thread.

Mount and grease the O-ring

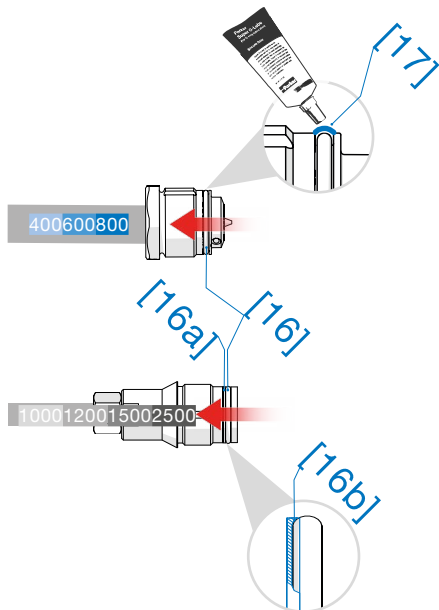



Unscrew the pressure housing

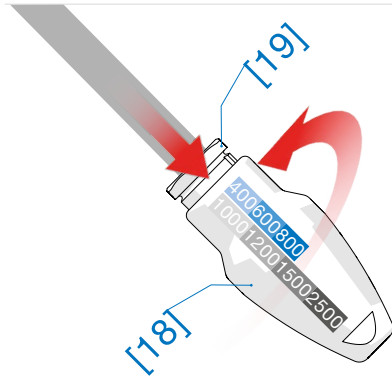

### Assembling the rotor nozzle

- ▶ Hold the pressure housing [18] at a 45° angle with the opening facing upwards.
- ▶ Screw the driving plug [19] into the pressure housing as far as it will go. **ATTENTION** – the rotor may not be jammed.
- ▶ Screw the pressure housing [20] tightly with the ring spanner [21] (25 Nm).

Tighten the pressure housing with 25 Nm

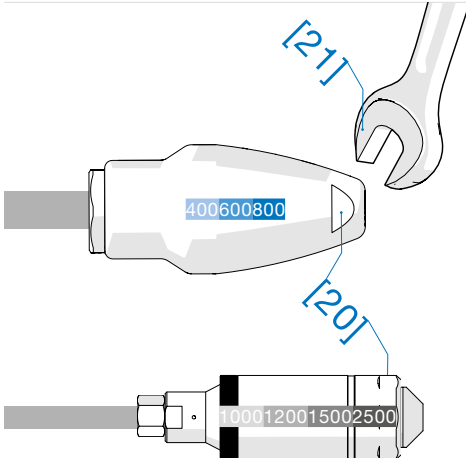



## Store the rotor nozzle

Here you will find information about storing the rotor nozzle.





Empty the rotor nozzle

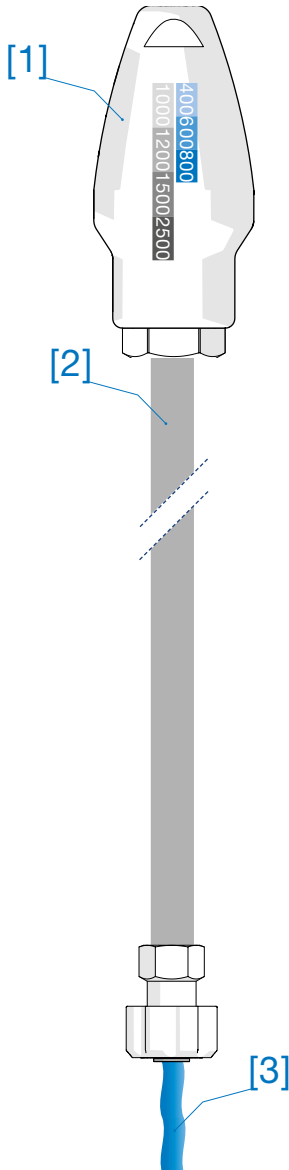

## Storing the rotor nozzle

### Drain rotor nozzle

- ▶ Separate the high pressure lance [2] with the rotor nozzle [1] from the high pressure gun.
- ▶ Allow the water [3] to run out of the rotor nozzle.
- ▶ Dry the rotor nozzle with a cloth.

### NOTICE

#### Frost damage

- ▶ Make sure the rotor nozzle does not freeze up. This can cause damage to components.  
This protects the rotor nozzle against frost damage.



## Dispose of rotor nozzle

Information about disposal of the product and the associated components can be found here.



# What happens with the waste?



## Packaging

▶ The packaging is made of cardboard and can be recycled.

## Protective cap, rotor, bearing unit

▶ These components can be disposed of with non-recyclable waste.

## Pressure housing, driving plug

▶ These components can go into metal recycling.

## Consumable water

▶ The water that is contaminated by the cleaning process must be disposed of in accordance with the regulations in the event of environmentally harmful contamination.

## CAUTION

### Risk of injury during disassembly

▶ Wear gloves during disassembly. This will protect your skin from abrasions and pinching.

